



Quick Manual
capa**NCDT 6200**

DT6220
DT6222
DT6228
DT6230
DT6238

Contents

General	3
Symbols Used.....	3
Warnings	3
Intended Use.....	4
Proper Environment.....	5
Setup, Connection Options	6
Ground Connection, Grounding.....	7
Synchronization	8
Assembly	9
Sensor.....	9
Controller	10
Inserting Demodulator Module.....	11
Commissioning	13
LEDs.....	13

Commissioning, IP Address	16
Channel Information, Measuring Range.....	17
Math Function	17
Positioning the Target	18
Distance Measurements	18
Operation and Maintenance	19
Disclaimer	19

MICRO-EPSILON
MESSTECHNIK
GmbH & Co. KG
Koenigbacher Str. 15

94496 Ortenburg / Germany

Tel. +49 (0) 8542 / 168-0
Fax +49 (0) 8542 / 168-90
e-mail info@micro-epsilon.com
www.micro-epsilon.com

You can find further information about the measurement system in the operating instructions. They are available at:

www.micro-epsilon.com/download/manuals/man--capaNCNT-6200--en.pdf
www.micro-epsilon.com/download/manuals/man--capaNCNT-6222--en.pdf
www.micro-epsilon.de/download/manuals/man--capaNCNT-6228-6238--en.pdf



General

Symbols Used

The following symbols are used in this document:



Indicates a hazardous situation which, if not avoided, may result in minor or moderate injury.



Indicates a situation that may result in property damage if not avoided.



Indicates a user action.



Indicates a tip for users.

Measure

Indicates hardware or a software button/menu.



Sensor measurement direction

Warnings



Disconnect the power supply before touching the sensor surface.

> Risk of injury, static discharge

Connect the power supply and the display/output device according to the safety regulations for electrical equipment.

> Risk of injury, damage to or destruction of the sensor and/or the controller



Avoid shocks and impacts to the sensor and the controller.

> Damage to or destruction of the sensor and/or the controller

The supply voltage must not exceed the specified limits.

> Damage to or destruction of the sensor and/or the controller

Protect the sensor cable against damage.

> Destruction of the sensor, failure of the measurement system.

Intended Use

- The system is designed for use in an industrial environment. It is used for
 - measuring displacement, distance, movement and thickness,
 - measuring the position of parts or machine components.
- The measuring system must only be operated within the limits specified in the technical data.
- The measuring system must be used in such a way that no persons are endangered or machines and other material goods are damaged in the event of malfunction or total failure of the measuring system.
- Take additional precautions for safety and damage prevention in case of safety-related applications.

Proper Environment

Temperature range controller	Operation		Storage
	+10 ... +60 °C (+50 ... +140 °F)		-10 ... +75 °C (+14 ... +167 °F)
Temperature range sensor	Operation		Storage
CS005, CS02, CS05, CS08, CS1, CS2, CS3, CS5, CS10	-50 ... +200 °C (-58 ... +392 °F)		-50 ... +200 °C (-58 ... +392 °F)
CSH02, CSH05, CSH1, CSH1.2, CSH2			
CSH02FL, CSH05FL, CSH1FL, CSH1.2FL, CSH2FL, CSH3FL			
CSE01, CSE05, CSE025, CSE1, CSE2			
CS1HP			
CSG0.50, CSG1.00	-50 ... +100 °C (-58 ... +212 °F)	-50 ... +100 °C (-58 ... +212 °F)	
CSE-x/HT/CA-1,0	Sensor with cable: -50 ... +800 °C (-58... +1472 °F)		-50 ... +200 °C (-58 ... +392 °F)
	Plug: -50 ... +200 °C (-58 ... +392 °F)		
Temperature range sensor cable	Operation		Storage
	Up to 10,000 operating hours	Permanent	
CCgxC, CCgxC/90	-20 ... +100 °C (-4 ... +212 °F)	-20 ... +80 °C (-4 ... +176 °F)	-50 ... +80 °C (-58 ... +176 °F)
CCgxB, CCgxB/90			
CCmxC, CCmxC/90		-100 ... +200 °C (-148 ... +392 °F)	-50 ... +200 °C (-58 ... +392 °F)
CCmxB, CCmxB/90			

Protection class IP40

Humidity 5 ... 95 % (non-condensing)

Ambient pressure Atmospheric pressure

The space between sensor surface and target must have an unchanging dielectric constant.

Setup, Connection Options

Power supply and signal output are provided via plug connectors on the front of the controller.

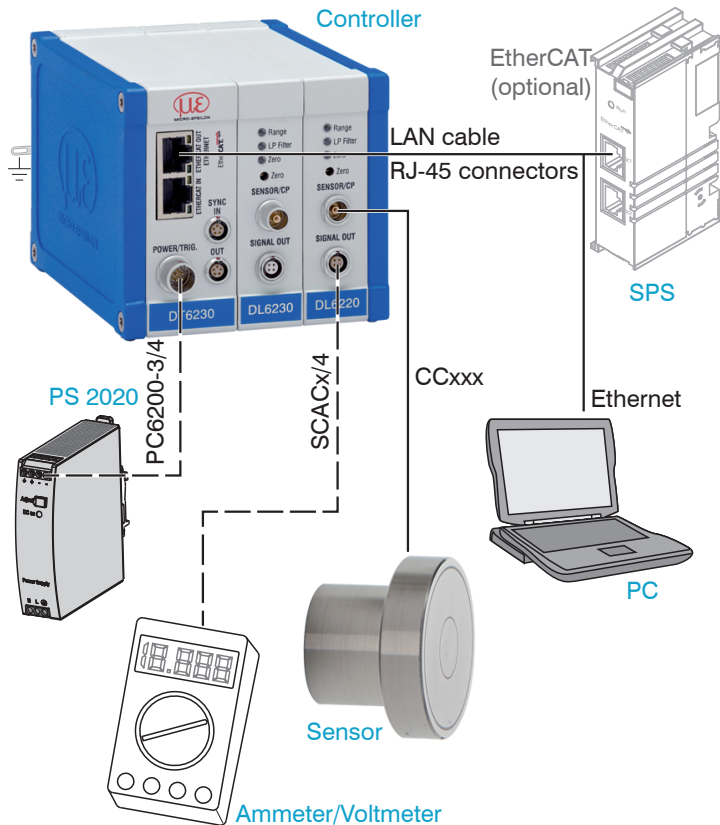

Ground Connection, Grounding

- Ensure sufficient grounding of the target, for example, by connecting it to the sensor or the power supply ground. If necessary, use the grounding connection on the housing cover. The grounding connection is included in the conversion kit supplied in the scope of delivery.

Non-contact target grounding

Grounding the target is very difficult or even impossible in many applications. Unlike common systems, the target does not need to be grounded if two DL62xx demodulators are synchronized.

The schematic diagram below shows two synchronized capaNCDT sensors that measure against a roll. Since the sensors are connected by MICRO-EPSILON's unique synchronization technology, grounding of the target is not required in most cases.

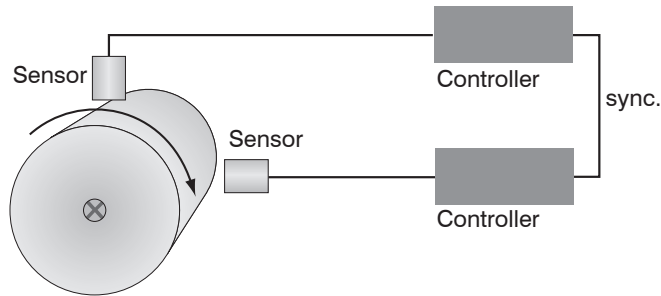

Position and imbalance measurement with two measurement systems

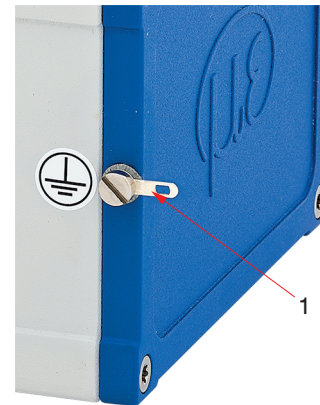

Grounding connection on the housing cover (1)

Target grounding is not required with synchronized capaNCDT sensors by Micro-Epsilon.

Synchronization

All sensors are synchronized with each other within one controller. Several capaNCDT 6230 and 6238 series controllers can be operated simultaneously as a multi-channel system. Synchronizing the controllers prevents interference of the sensors with each other.

External synchronization DT6230

PIN	Assignment	Insulation	Color
1	n.c.	-	-
2	Twisted pair 1	1	white 1
3	Twisted pair 1	blue	blue
4	Twisted pair 2	2	white 2
5	Twisted pair 2	orange	orange

SC6000-x is an assembled synchronization cable which is 0.3 or 1 m long

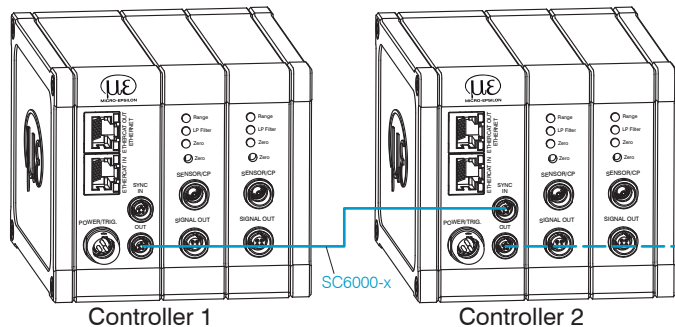

Synchronization of a second DT6230 controller

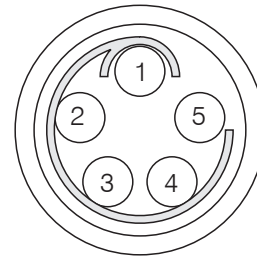

View: solder side,
5-pin ODU male cable
connector

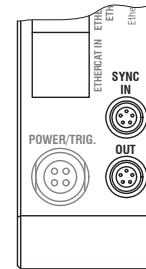

IN/OUT sync on the
controller, 5-pin female
connector

- Plug the SC6000-x synchronization cable into the SYNC OUT port (output) on Controller 1.
- Plug the connector of the SC6000-x into the SYNC IN port (input) on Controller 2.

i Automatic synchronization, each controller can be the master.

Assembly

No sharp or heavy objects should be allowed to affect the cable sheath.

i A damaged cable cannot be repaired. Tension on the cable is not permitted!

Sensor

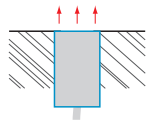

Flush installation

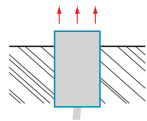

Protruding installation

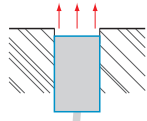

Recessed installation, not for sensors in the CSE series

During installation, take care that the sensor front face is not scratched.

Clamping Around Circumference, Cylindrical Sensors

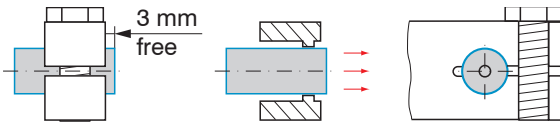

Clamping around circumference, assembly with clamping collet

- High reliability
- Flat clamping across cylindrical housing
- Recommended assembly for e.g., machines, production facilities, etc.

Radial Spot Clamping with Grub Screw, Cylindrical Sensors

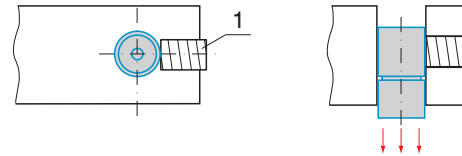

Radial spot clamping with grub screw (1)

- Simple mounting option
- Recommended assembly only for installation locations that are free of impact or vibration
- The grub screw must be made of plastic

Do not use metal grub screws!
> Risk of damage to the sensor

Flat Sensors

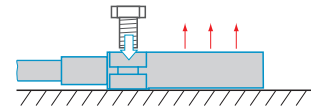

Screwed connection from top

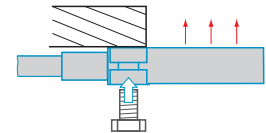

Screwed connection from bottom

Controller

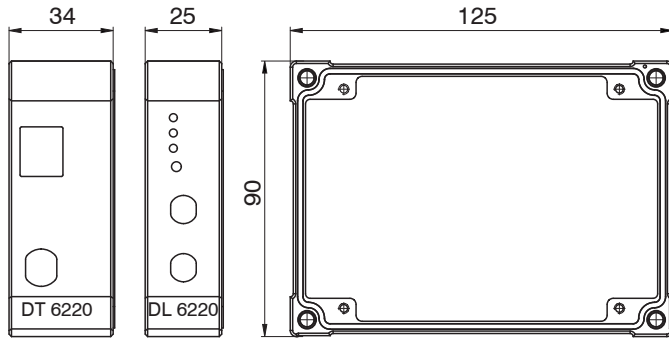

Dimensional drawing of base module and demodulator module

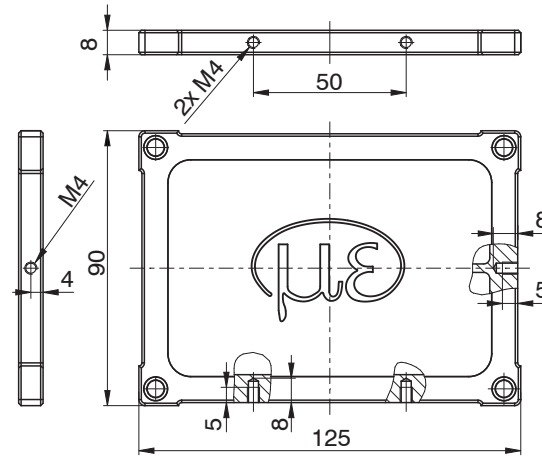

Dimensional drawing of housing cover

Inserting Demodulator Module

- ▶ Loosen the sleeve nuts (4b) on the right side of the controller, remove the right housing cover (3).
- ▶ Pull out a sleeve nut (4a), including the threaded rod (1).
- ▶ Replace the threaded rod (1) with the next-longest threaded rod in the conversion kit supplied. Push the new threaded rod, including sleeve nut (4a), through the modules.
- ▶ Replace the remaining 3 threaded rods in the same manner.
- ▶ Attach the additional demodulator module.

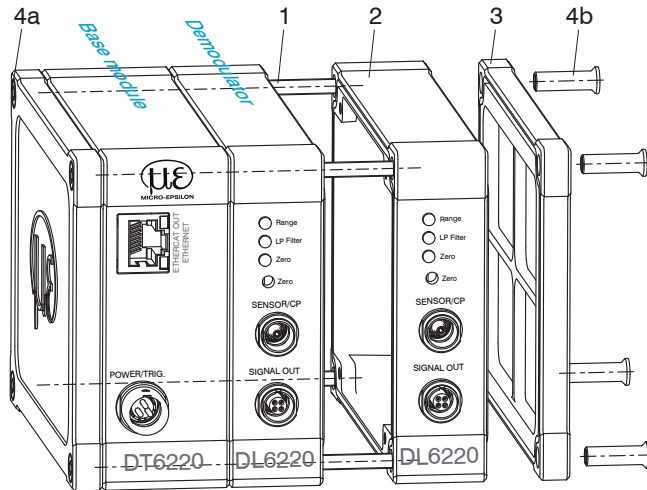

Number of demodulator modules	Length of threaded rod M4
1	59 mm
2	84 mm
3	109 mm
4	134 mm

Controller mechanical parts

i Only touch the demodulator modules on the housing, not on the electronics. This avoids electrostatic discharges onto the electronics.

- Connect both flat strip connections (5) of the previous demodulator module to the new demodulator module (6).

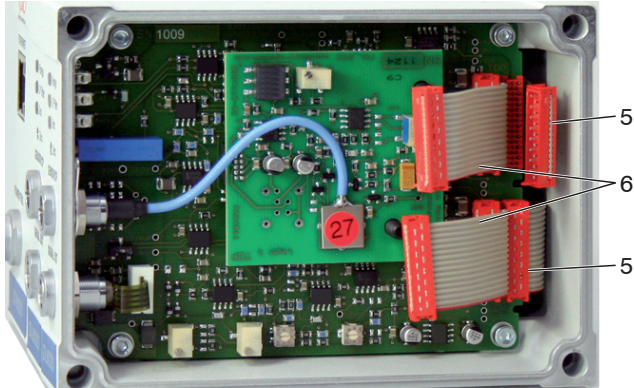

Wiring of demodulator modules

- 5 Wiring of previous demodulator module
- 6 Wiring of next demodulator module

- Attach the right housing cover (3).
- Screw the sleeve nuts (4b) onto the threaded rods on the right side of the controller and tighten the sleeve nuts.

Wiring to the previous demodulator module (5) can be released by using the supplied unplugging tool – see Accessories – as follows:

- 1. Push the unplugging tool with the cutout side-ways onto the plug (5).
- 2. Remove the plug with a lever movement.
- 3. Release the other side of the plug in the same manner.

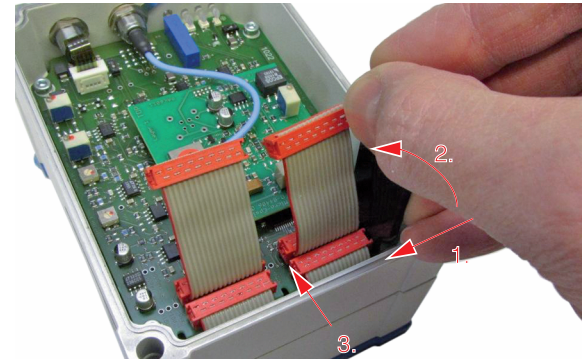





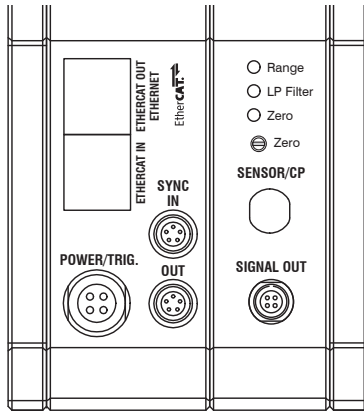

Use of the unplugging tool for wiring of the demodulator elements

Commissioning

LEDs



1) LP Filter can only be switched via Ethernet.

LED	Color	Function
Range	 green	Target within the measuring range
	 red	Measuring range exceeded
LP Filter ¹	 off	Default strip width active
	 red	20 Hz low-pass filter at analog outputs enabled.
Zero	 off	Zero potentiometer in base position (right-hand stop)
	 red	Zero potentiometer misaligned

Pin Assignment Supply, Trigger

Pin	Wire color PC6200-3/4	Description
1	Brown	+24 VDC supply
2	White	GND supply
3	Yellow	Trigger IN+, TTL level
4	Green	Trigger IN-
Shield		

PC6200-3/4 is an assembled supply and trigger cable that is 3 m long.

Pin Assignment of Analog Output

Pin	Wire color SCACx/4	Description
1	Brown	V_{OUT} (Load min. 10 kOhm)
2	Yellow	I_{OUT} (Load max. 500 Ohm)
3	Gray	GND, analog ground
4	White	GND, analog ground
Shield		

Analog grounds are connected internally. SCA-Cx/4 is a 4-wire output cable that is 3 m long. It is supplied as an optional accessory.

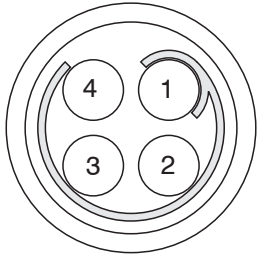

View: solder side, 4-pin ODU female connector

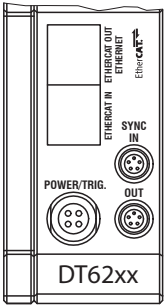

Supply input on controller, 4-pin plug

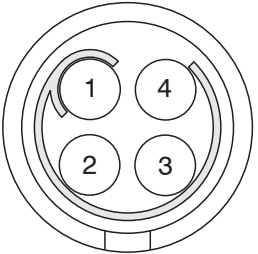

View: soldering pin side, 4-pin male cable connector



Signal output on controller, 4-pin port

Ethernet/EtherCAT Switching DT6230

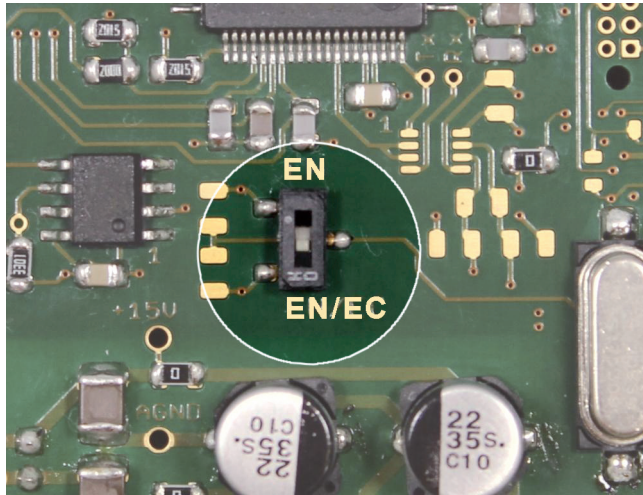

Switch for changing between Ethernet and EtherCAT

You can change between Ethernet and EtherCAT by using the hardware switch on the DT6230 resp. DT6238 base module or in the software.

If the switch is in the **EN** (Ethernet) position, the Ethernet interface is always active irrespective of the software setting. If the switch is in the **EN/EC** (Ethernet/EtherCAT) position, the interface set by the software is active. Any change to the interface only takes effect after restarting the controller.

Commissioning, IP Address

The controller is shipped with the factory-set IP address `169.254.168.150`.

You can query the IP addresses of the controllers that are connected to a PC or network by using the `sensorTOOL` program. This program is available online at <https://www.micro-epsilon.com/download/software/sensorTOOL.exe>.

- ▶ Start the `sensorTOOL` program and click the  button.
- ▶ Select the correct controller from the list.
- ▶ Click the `Open Website` button to connect the sensor to your default browser.

OR: If DHCP is active and the DHCP server is linked to the DNS server, access is also possible by using e.g., `DT6200_SN01234567` (where “01234567” is the serial number of your controller).

- ▶ Start a web browser on your PC. Enter `DT6200_Serial_number` in the address bar of your browser.

The controller supports UPnP. If you have an operating system where the UPnP service is enabled, e.g. by default in Windows 7, the controller is automatically listed in Explorer under network devices and can be accessed from there, e.g. if you have forgotten its IP address.

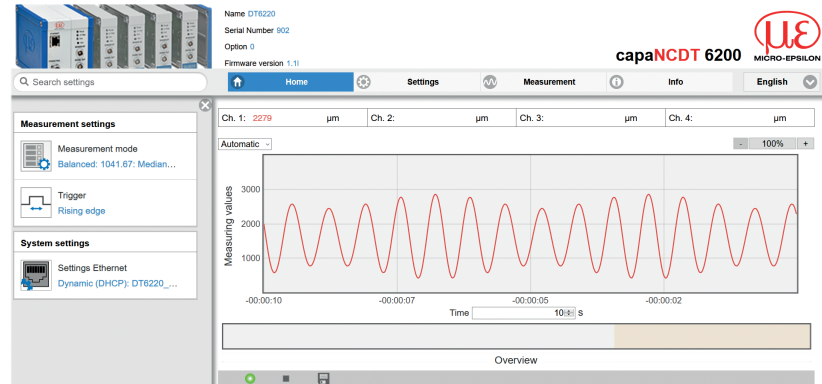

First interactive web page after calling the IP address

Additional help functions (e.g. `Settings`) are available in the top navigation bar. All settings on the web page are implemented in the controller immediately.

Parallel operation with web browser and Telnet commands is possible; the last setting applies.

The appearance of the web pages can change depending on the functions and the peripherals. Each page contains parameter descriptions and thus tips for configuring the controller.

Channel Information, Measuring Range

The measuring ranges of the connected sensors must be specified manually. After replacing a sensor, don't forget to specify its new measuring range.

➤ Go to the `Settings > Channel n > Channel information` menu.

➤ Specify the measuring range of the sensor.

Data channel	1/2/3/4	Value
--------------	---------	-------

Value range between 0 and 1000000 μ m Value range between 0 and 1000000 μ m

Math Function

This function permits scaling of a measuring channel and mathematical linking of individual measuring channels.

Formula: $\text{Data channel} = \text{Offset} + \text{Factor Measuring channel 1} + \text{Factor Measuring channel 2} + \text{Factor Measuring channel 3} + \text{Factor Measuring channel 4}$.

Data channel = digital values

Measuring channel = analog value of a demodulator module

➤ Go to the `Settings > Channel n > Math function` menu.

➤ Specify the values for Offset and Factor.

Data channel	1/2/3/4	Offset	Value
		Factor measuring channel	Value

Value range for Offset: max. ± 8 times MR

Value range for Factor: measuring channel between -9.9 and +9.9

Positioning the Target

- Position the target within the sensor measuring range.

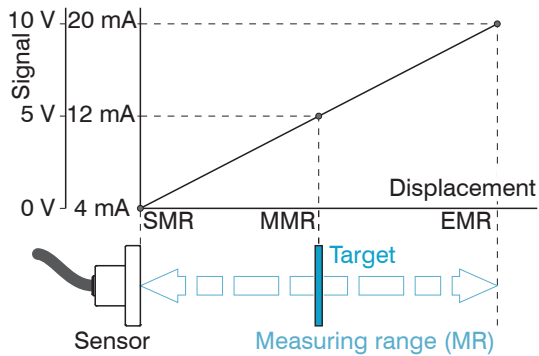

SMR Start of measuring range
 MMR Mid of measuring range
 EMR End of measuring range

Distance Measurements

- Switch to the Measurement menu.
- Click the Start measuring button.

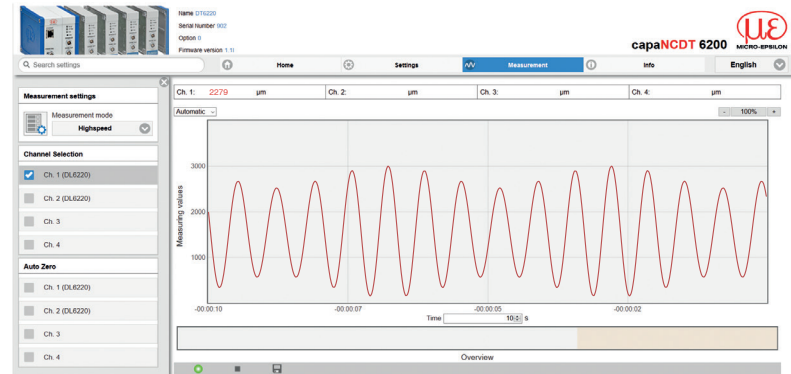

Operation and Maintenance

Please note for operation and maintenance:

- Ensure that the sensor surface is always clean.
- Before cleaning, turn off the supply voltage.
- Clean with a damp cloth and then rub the sensor surface dry.

If the target has been changed or operating periods are very long, minor losses in operating quality are possible. You can correct these long-term errors by recalibrating.

- Disconnect the power supply before touching the sensor surface.
- > Static discharge, danger of injury

If the cause of a fault cannot be clearly determined, always send the complete measurement system. In case of a defect in the controller, the sensor or the sensor cable, send the affected parts for repair or exchange.

MICRO-EPSILON MESSTECHNIK

GmbH & Co. KG

Koenigbacher Str. 15
94496 Ortenburg / Germany

Tel. +49 (0) 8542 / 168-0 / Fax +49 (0) 8542 / 168-90
info@micro-epsilon.com / www.micro-epsilon.com

Disclaimer

All components of the device have been checked and tested for functionality in the factory. However, should any defects occur despite careful quality control, these shall be reported immediately to MICRO-EPSILON or to your distributor / retailer.

MICRO-EPSILON undertakes no liability whatsoever for damage, loss or costs caused by or related in any way to the product, in particular consequential damage, e.g., due to

- non-observance of these instructions/this manual,
- improper use or improper handling (in particular due to improper installation, commissioning, operation and maintenance) of the product,
- repairs or modifications by third parties,
- the use of force or other handling by unqualified persons.

This limitation of liability also applies to defects resulting from normal wear and tear (e.g., to wearing parts) and in the event of non-compliance with the specified maintenance intervals (if applicable).

MICRO-EPSILON is exclusively responsible for repairs. It is not permitted to make unauthorized structural and / or technical modifications or alterations to the product. In the interest of further development, MICRO-EPSILON reserves the right to modify the design.

In addition, the General Terms of Business of MICRO-EPSILON shall apply, which can be accessed under Legal details | Micro-Epsilon <https://www.micro-epsilon.com/impressum/>.

For translations into other languages, the German version shall prevail.



MICRO-EPSILON MESSTECHNIK GmbH & Co. KG
Koenigbacher Str. 15 · 94496 Ortenburg / Germany
Tel. +49 (0) 8542 / 168-0 · Fax +49 (0) 8542 / 168-90
info@micro-epsilon.com · www.micro-epsilon.com
Your local contact: www.micro-epsilon.com/contact/worldwide/



X9691298-B012033DTa

© MICRO-EPSILON MESSTECHNIK